

- INSTRUCTION MANUAL -

TRIANGLE LEG COLLECTION



DESIGN BY SIMON JONES

HAY

- PARTS -

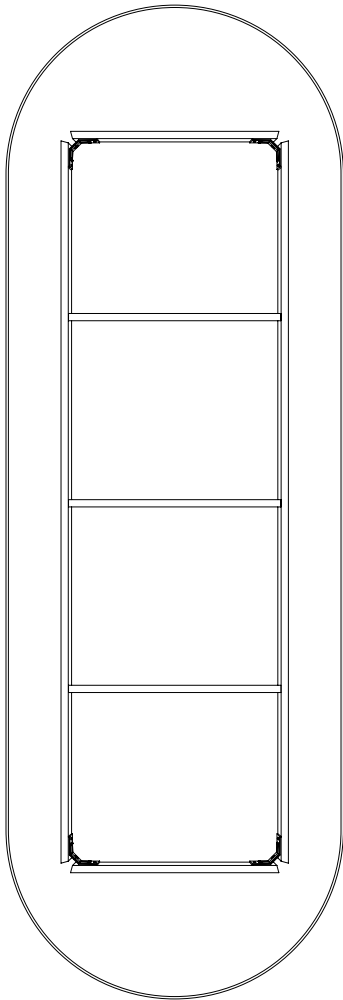

A Tabletop x1



B Leg x4



C Washer x4



D Nut x4



E Wrench x1

Protect the table top from scratches and other damage while assembling.

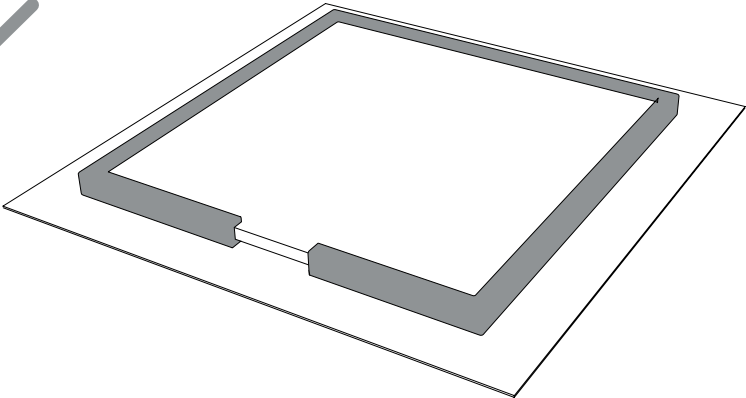
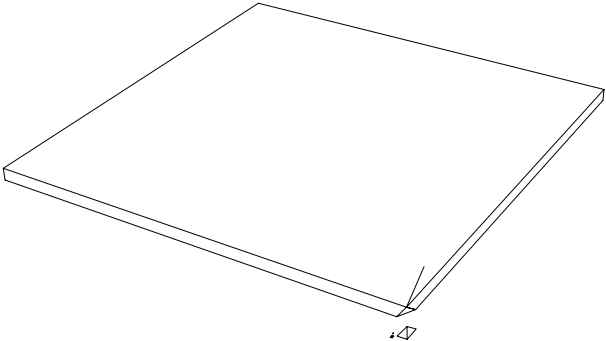

1.

Slide the bolt attached to the **B** part through the hole in the corner fitting of the **A** part. Thread the **C** part onto the bolt and secure with the **D** part.
Repeat the same procedure for all four legs.

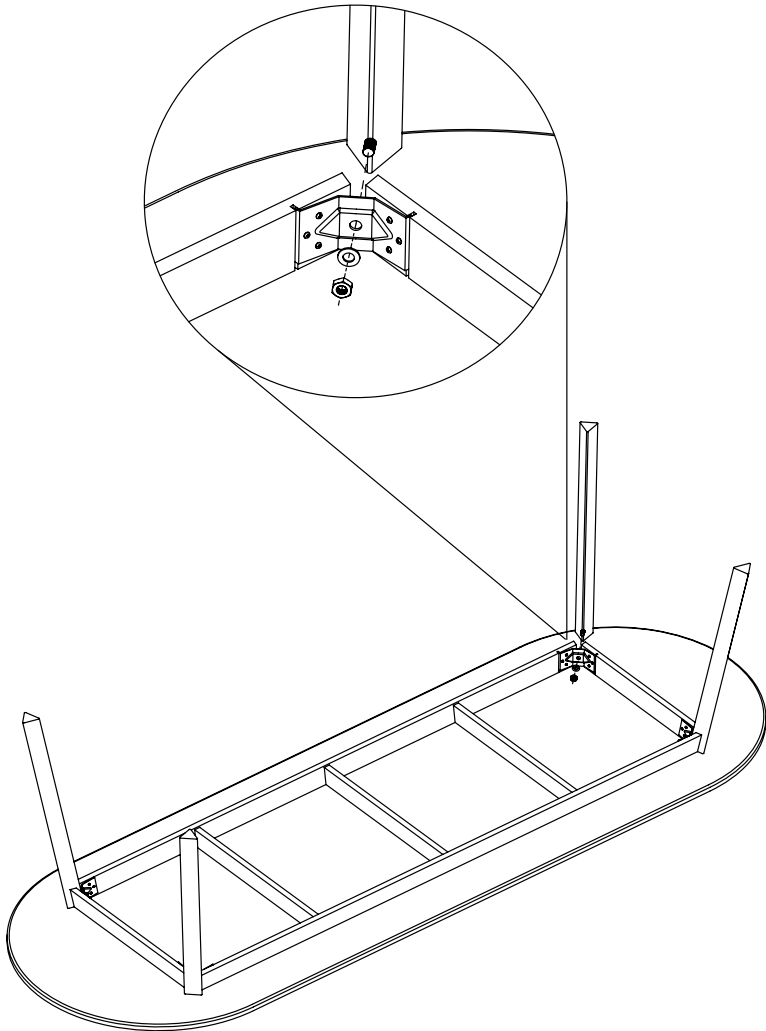

2.

Use the **E** part to tighten the **D** part.
Repeat the same procedure for all four legs.

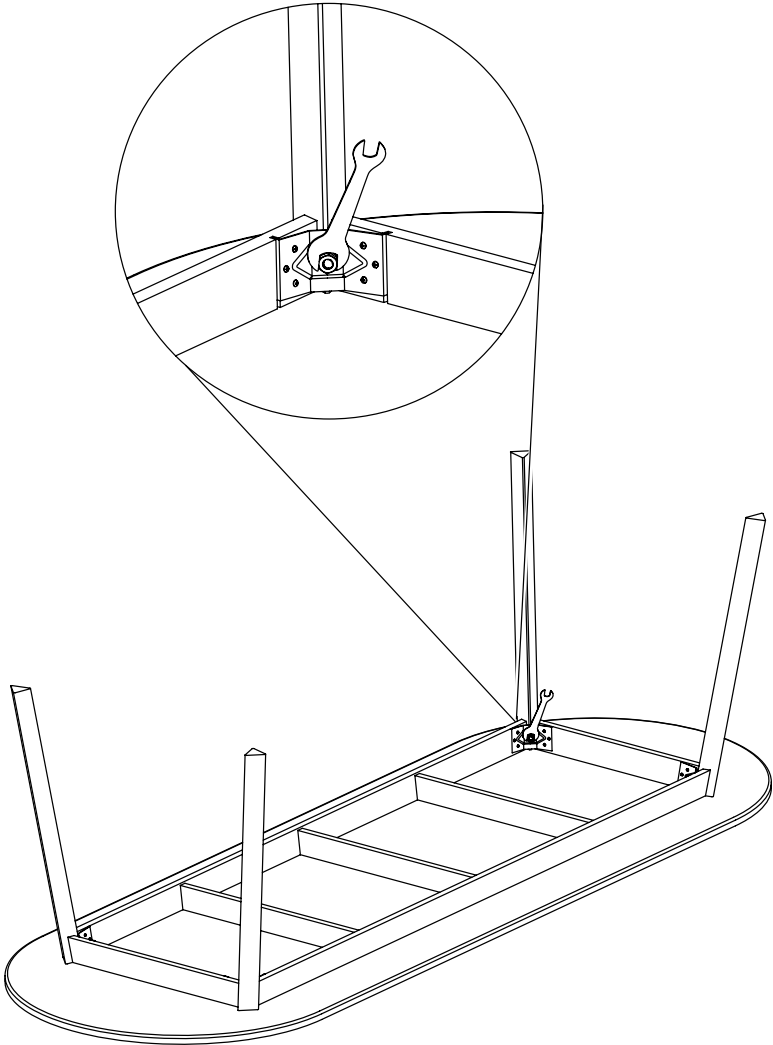

3.

Turn the table over and make sure all bolts are completely tightened.
(2 persons recommended).

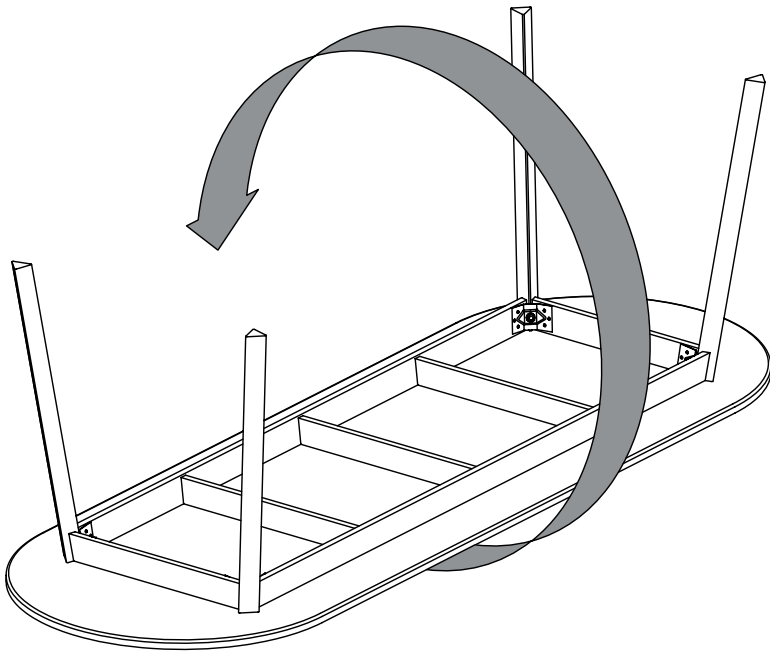

4.

Done!

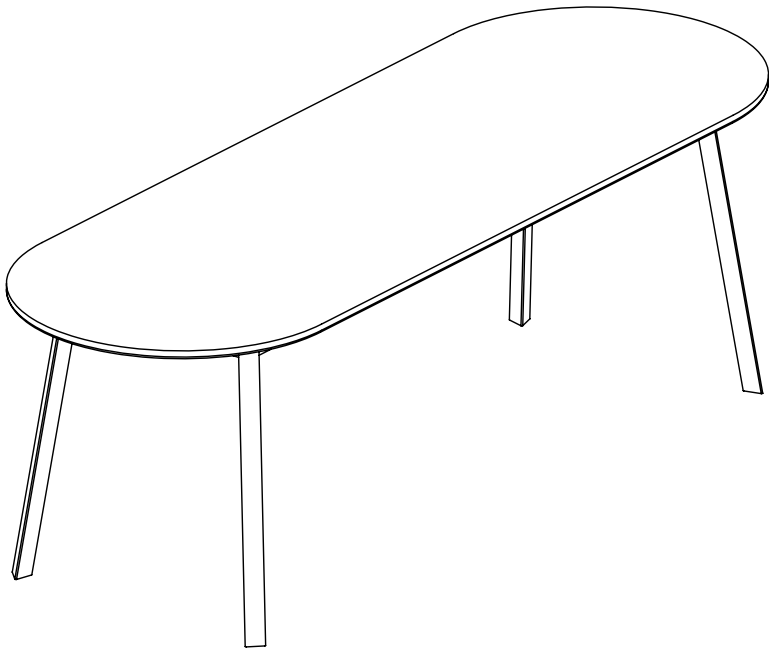

- CARE & MAINTENANCE -

Our Care & Maintenance offers guidance for optimal maintenance of your HAY product. It includes advice and instructions on cleaning and caring for specific materials to prolong the life of your furniture.



Please find our Care & Maintenance guide by scanning the QR code



You can find more relevant information on Triangle Leg Collection by scanning the QR code

You can also find the same information here
hay.dk/downloads

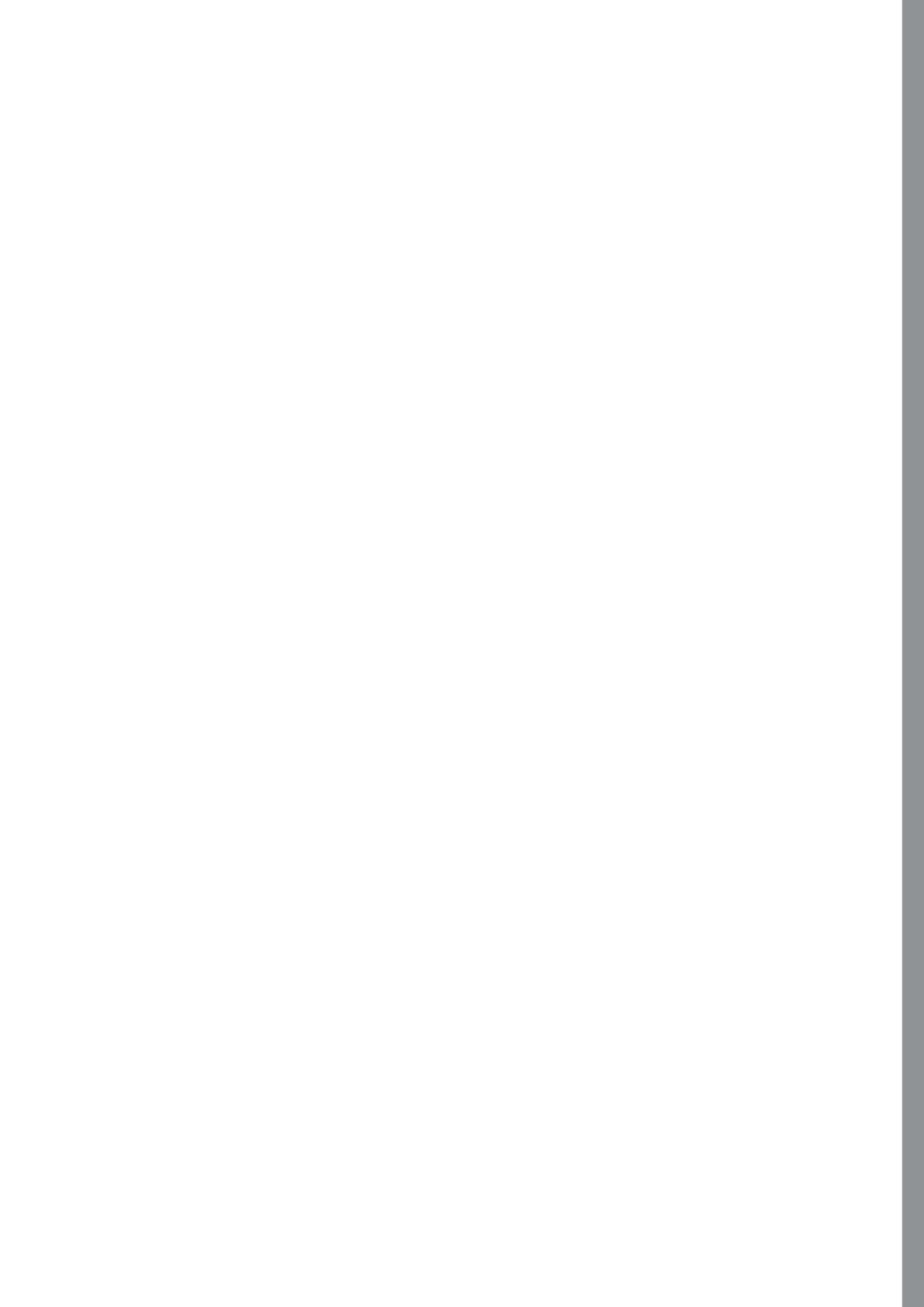

Havnen 1 8700 Horsens Denmark
+45 3164 6000 / hay@hay.com

10/01/2023

HAY